



# BALUSTRADE

## INSTALLATION MANUAL

## INSTALLATION

Remember to pre-drill any hole to at least 100% of the width required.

Builddeck installation manuals are designed as a quick and simple manual. They may not cover every installation scenario envisaged. Since each installation is unique; the installation method used and/or the actual installation and its actual performance are the sole responsibility of the installer.

Builddeck recommends that all designs be reviewed by a licensed architect, or engineer before installation.

Please ensure your plan and/or design meets building regulations and permission before you begin installation.

If you are unsure of the best practices, please use suitably qualified personnel to prevent injuries or accidents.

## Balustrade Product List

### IMPORTANT NOTE:

Your order may be missing some of the below items as they may be not required or necessary for your project. See your Delivery Note and Invoice to see what quantities and items you have ordered.

TBN01	WPC POST		1200 x 120 x 120mm 11.75Kg per length	TBN05	POST CAP		120 x 120mm
TBN02	TOP & BOTTOM HANDRAIL		1500 x 100 x 50mm 3.59Kg per length	TBN08	STAINLESS STEEL L SHAPED BRACKET		40 x 46 x 80mm 0.22Kg per 100pc
TBN04	WPC SPINDLES		L 755 x 50 x 50mm S 205 x 50 x 50mm	TBN06	SLIDE ON POST SKIRT		120 x 120 x 45mm 0.13Kg per piece
TBN07	SPINDLE RUBBER CLIP		35 x 35mm	TBN01	POST REINFORCEMENT		1500 x 80 x 80mm
TBN010	POST REINFORCEMENT		1000 x 80 x 80mm with base	TBN02	HANDRAIL INSERT		1500 x 30 x 40mm 0.22 Kg per 100pc

## FIXING POSTS

### Option I

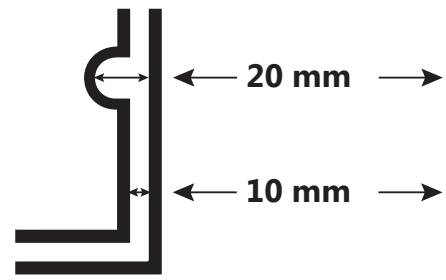
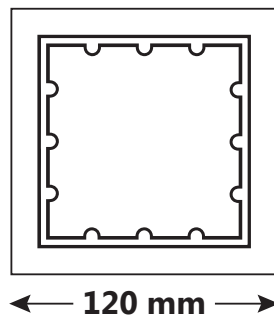
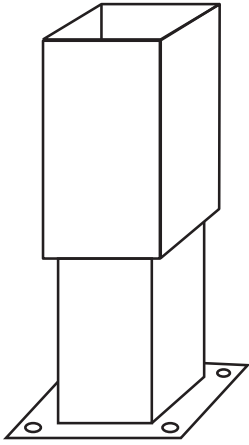

#### FIXING TO GROUND USING AN ERECTA PLATE

1. Bolt erecta plates into your solid base.
2. Insert galvanised steel posts into the erecta plates and secure in place.
3. Slide your Newell Posts over the galvanised steel post.
4. Ensuring to leave enough inside gap for expansion. See above.

### Option II

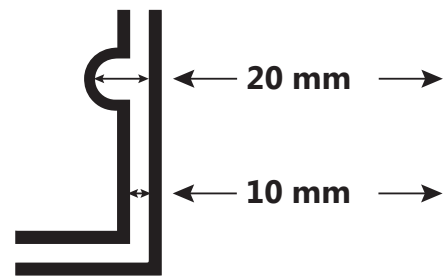
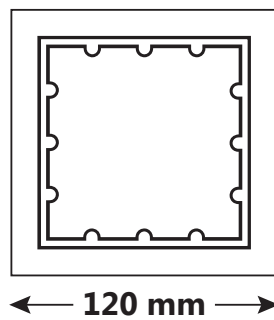
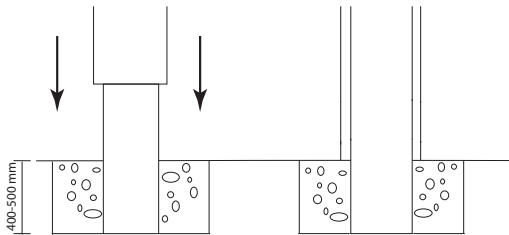

#### FIXING TO GROUND USING CONCRETE

1. Dig holes suitable for your galvanised steel posts.
2. Bury the galvanised steel post and concrete it into the ground (400 mm).
3. Ensuring to leave enough inside gap for expansion. See above.

### Option III

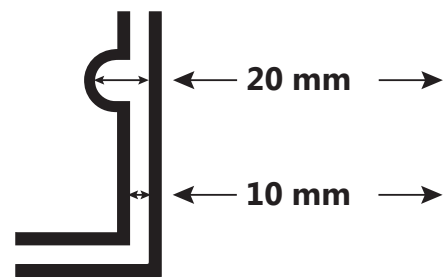
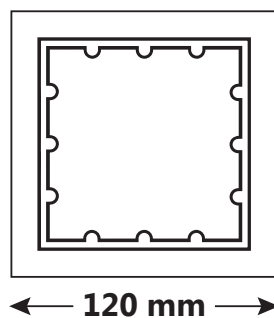
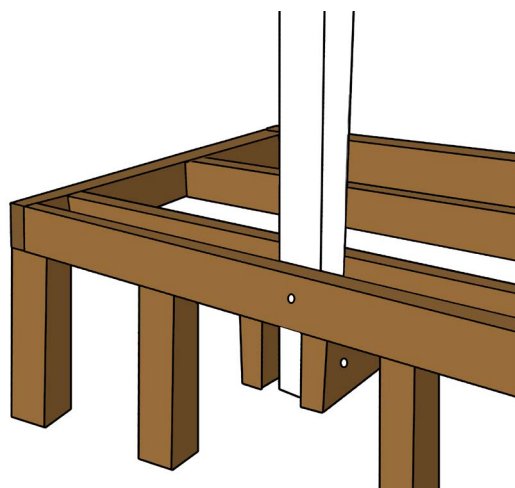

#### FIXING TO TIMBER SUBFRAME

For advice, please contact a structural engineer if your proposed area is above ground floor level.

1. Cut your galvanised steel and newell posts to wanted height.
2. Cut crossbearers out of timber to hold galvanised steel post in place.
3. Bolt galvanised steel crossbearers and posts together making sure everything is safe and secure.

# INSTALLATION MANUAL for Construction of Balustrade

**IMPORTANT:**

Leave 10mm gaps around newell posts for decking & post expansion.

Slot a Post Skirt on to disguise the gaps.

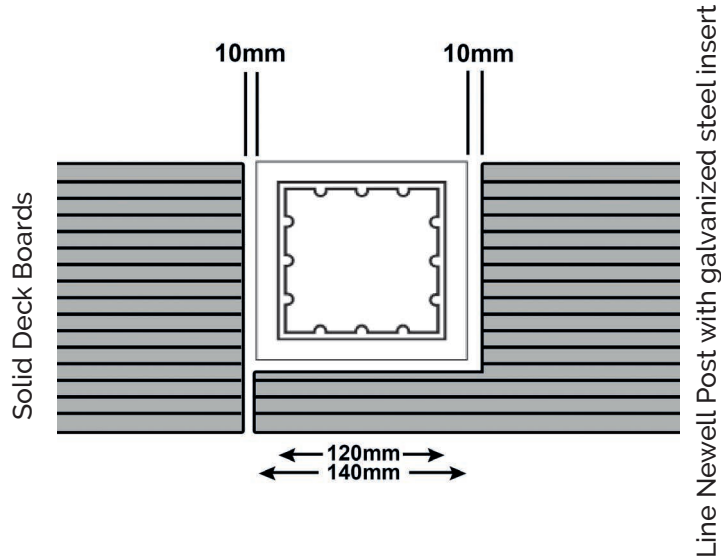

**Top Handrail**

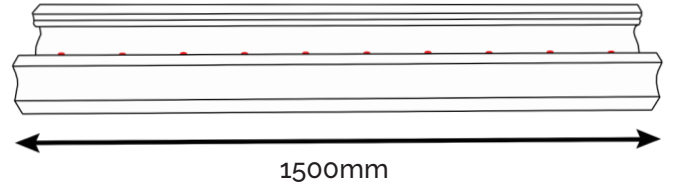

**Bottom Handrail**

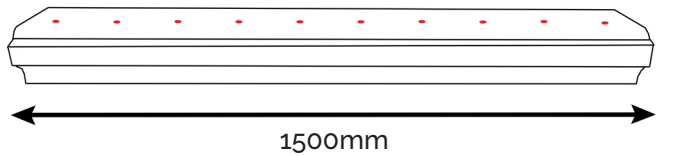

1. Cut your handrails to the correct length (max 1500mm).
2. Mark centre points of each of the Spindles location on the top & bottom handrails.  
**Pre-drill** the holes to at least 100% of the hole required. Spindles have to be spaced at 140mm centres to centres each other and 120mm centres the first and the last one from the posts.

**Please Note:** both the top and bottom handrail should be installed with the inner groove facing down.

**Remember to Pre Drill**

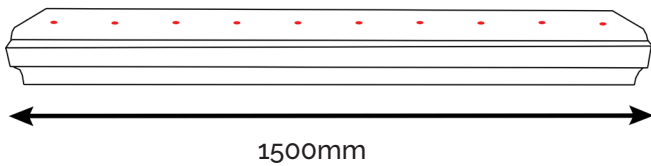
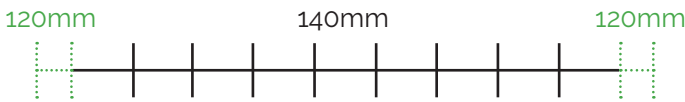
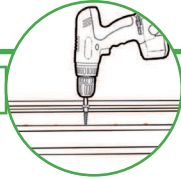

**Top Handrail**

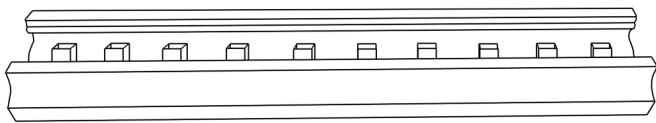

**Bottom Handrail**

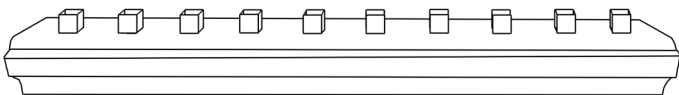

3. Screw the Spindle Clips into the pre marked rails using the screws provided.

Leave 3 mm gap between the top & the bottom handrail and the end of the spindles

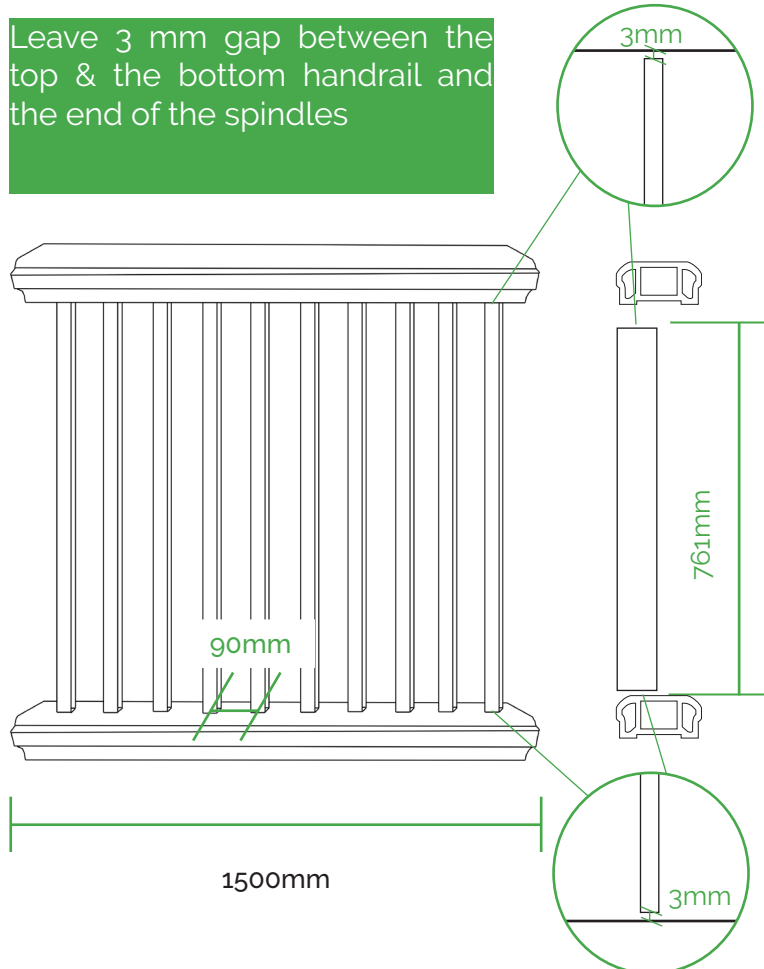

4. Push the Spindles into the U Shaped Connectors. Ensure the spindles are straight. The distance between the spindles is 90mm

# INSTALLATION MANUAL for Construction of Balustrade

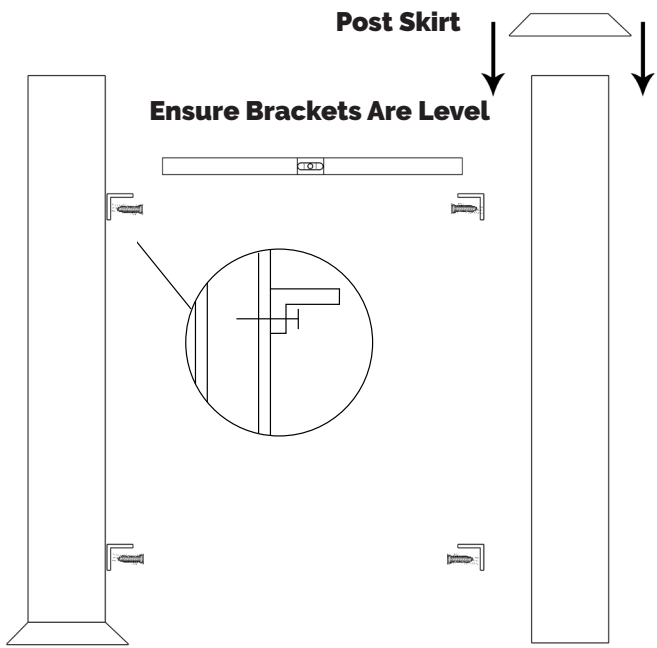

5. Slot the Post Skirts onto your Newell Posts.
6. Measure & screw the Stainless Steel L Shaped Brackets into the posts. Ensure they are level. Be careful not to over tighten screws into the post as damage may occur.
7. Place the Secure Spindle in the middle of the bottom rail

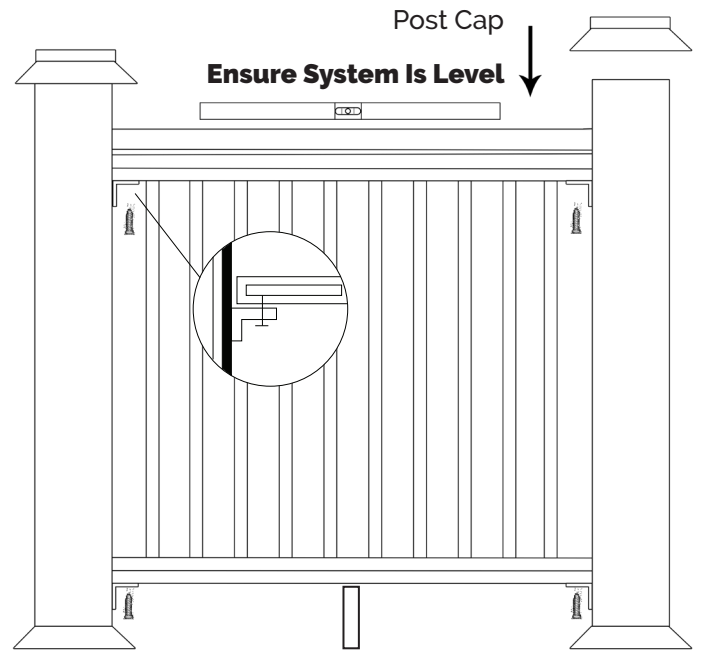

8. Secure the balustrade unit between the posts using the L Shaped Brackets and screws provided. **YOU MUST LEAVE A 3 MM GAP BETWEEN EACH END OF THE SPINDLES AND THE HANDRAILS**
9. Push Post Caps into place on top of the WPC Posts. You may need to grind the post corners to fit the caps on.

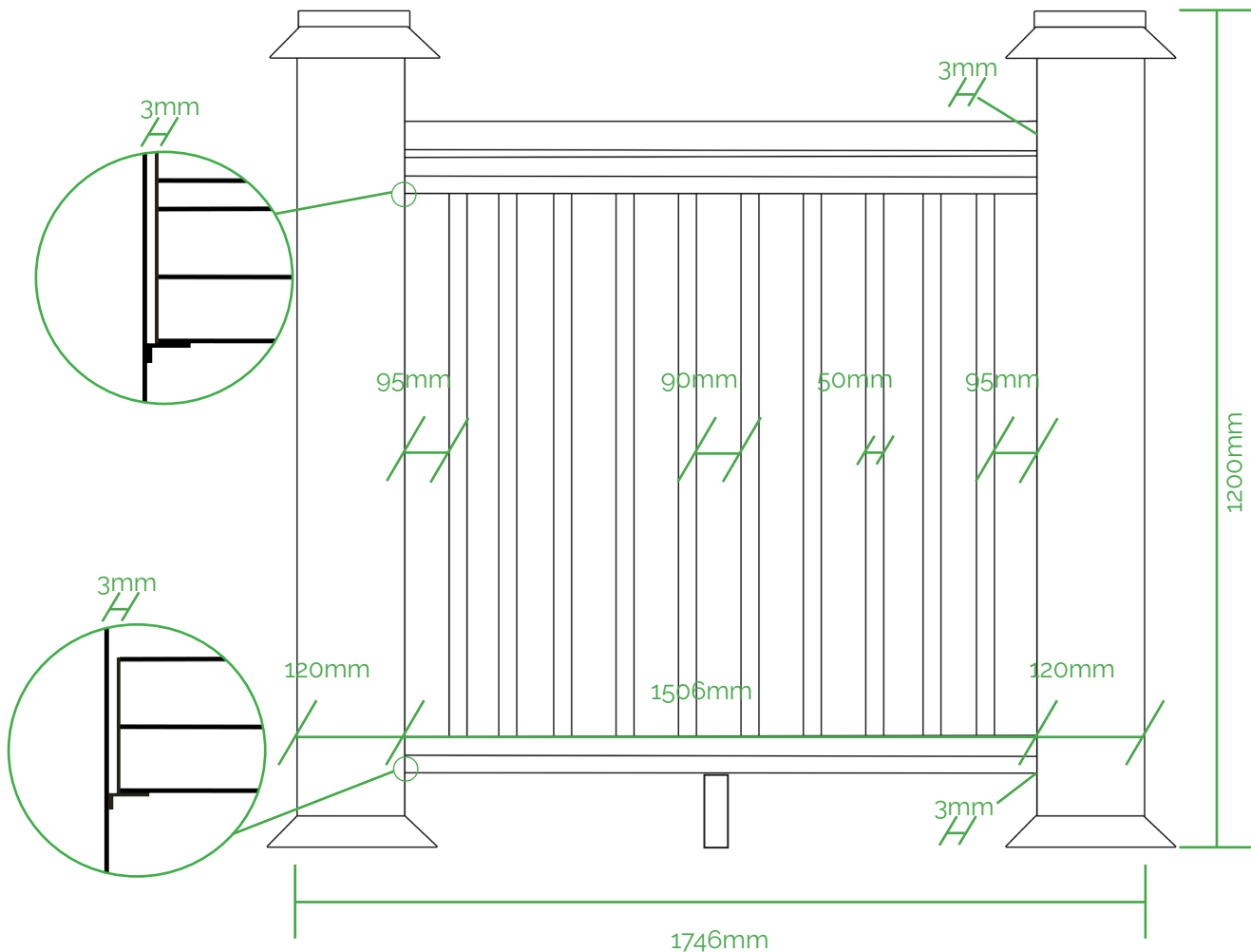

## **MAINTENANCE**

Regularly use a brush and hot soapy water to wash Builddeck WPC. For water stains or any marks caused by birds, berries or leaves, use a soft cleaning detergent to wash off. For harder stains such as marks containing dyes that leave permanent stains, clean the surface using wire wool or sandpaper lightly to carefully remove. If using a power washer to clean your product, keep a distance of at least 30cm from the boards.

Do not use solvent based materials on Builddeck WPC. Do not stain, oil or paint any Builddeck WPC without guidance.

## **MINOR DAMAGE**

As with any product that is meant for outdoor use, scratches and acts of nature will inevitably occur. If this does happen a 200 grit or finer sandpaper can be used to remove the scratch with no detrimental effect to the longevity and performance of the decking.

## **COLOUR EXPECTANCY**

Builddeck's composite products will fade due to sun bleaching over time. As our composite wood is a manmade partially recycled product, colour variations and dimension tolerance are to be expected.

Our warranty does not cover colour fade, discolouration tolerance or water marks, or stains on our products.

On deliveries colour variations may occur in different batches.

## **DISCLAIMER**

The information given in this publication is based on those guidelines for installation on domestic properties. Commercial decks require more robust design, materials and construction to deal with the loads placed on them and are not covered by the guidance in this brochure.

Builddeck installation manuals are designed as a general guide. They may not cover every installation scenario envisaged. Since each installation is unique; the installation method used and/or the actual installation and its actual performance are the sole responsibility of the installer.

Builddeck recommends that all designs be reviewed by a licensed architect or engineer before installation.

Please ensure your plan and/or design meets building regulations and permission before you begin installation.

If you are unsure of the best practices, please use suitably qualified personnel such as GQA accredited to prevent injuries or accidents and get the best performance from Builddeck products.

