



COMPOSITE DECKING

INSTALLATION MANUAL

CLIP SYSTEM

Select the location of your decking carefully taking into account privacy, sun, shade and wind. Consider the layout for exit and entry to the home.

Keep the size of the deck in proportion to your home and garden.

For all but a simple ground level decking, installers should satisfy themselves as to whether planning regulations apply. If you are unsure, always contact your local planning office to discuss your intentions.

DRAINAGE AND VENTILATION

When designing and building decking always plan to achieve a structure that will enable water to freely drain away via ground preparation, sub structure and the deck itself. If the water does not run off freely from the support structure or the water collects on the surface of the deck for a long period, the boards may start cupping and structural damage may occur due to moisture absorption.

To achieve rain water "run off", decking should be laid on a slight gradient of at least 1 in 80 (1.25%) in the direction of the long side of the boards in the grooves direction. Good drainage and ventilation around and under the deck is required.

SAFETY INSTRUCTIONS

When handling and processing Senate products always wear gloves, eye protection and work in a well ventilated area. Always wash your hands after handling Senate products, especially before smoking or eating. Wear eye protection when pressure washing or scrubbing the decking. Keep children and animals away from the work area until the job has been completed and the tools have been stored in a safe place. When cutting, planing or sanding our products, be aware that the creation of dust and noise will occur.

We recommend that all operatives carrying out these tasks wear suitable P.P.E. including gloves, eye protection, dust masks and ear defenders.

Slip tests pass results have been performed on the ridged side only of the boards.

STORAGE

Senate decking should be stored indoors. Full details on how to store are available upon request. If the product has no option other than to be stored outdoors, the decking should be kept in a covered area with its original package to prevent exposure to direct sunlight and weathering.

The area should be free draining, have good ventilation and be free from moisture with boards supported on level bearers at 300mm centres.

TOOLS REQUIRED TO INSTALL YOUR DECK

Prior to installing your decking, we recommend the below tools are available to ensure you have everything to hand to make the process run quickly and smoothly.



Circular Saw



Cordless
Drill / Screwdriver



Screwdriver Bit
suitable for
Senate supplied
screws



Spirit Level

Other Tools:

Spirit Level
Tape Measure
Pencil
Chalk Line
Work Gloves
Safety Glasses
Dust Mask
Hearing Protection



JOIST CONFIGURATIONS

A minimum of 200mm elevation between the ground and joists is required beneath Senate decking. Always leave at least 2 sides of the subframe open to allow for cross ventilation under the decking.

Always lay deckboards groove direction in the same direction of the drainage gradient so water can drain freely with a gradient across the whole length of the deck of at least 1:80 (1.25%).
Ventilation is very important, composite wood will absorb moisture from the ground beneath the deck. If adequate ventilation is not adhered to, the moisture underneath the deck is likely to cause swelling, eg. expansion, cupping and or bowing. Ventilation should always be considered prior to construction.

BOX CONSTRUCTION

Ideal for garden area that drains well.

- Replace 100mm topsoil with compacted gravel or hardcore.
- Position a minimum of 2 deck support posts in footings to act as frame anchors.
- Lay weed barrier.
- Lay subframe allowing for 50mm drainage gap all round and drainage gradient of 1:80 (1.25%) as standard.
- Attach to post anchors.
- Backfill around frame with gravel or pea shingle.
- Fit timber or composite newel posts after if balustrade is required.

RAISED DECK CONSTRUCTION

Ideal for sloping sites, multi-tier decks or where final deck height is not an issue.

- Install subframe allowing for 50mm drainage gap all round and drainage gradient of 1:80 (1.25%) as standard.
- Lateral bracing of the beams may be necessary.
- Ensure industry standard balustrading regulations are met.
- Fit timber or composite newel posts after construction if balustrade is required.

LOW LEVEL CONSTRUCTION

Ideal for restricted final deck height.

- Install subframe allowing for 50mm drainage gap all round and drainage gradient of 1:80 (1.25%) as standard.
- Ensure suitable ventilation is available.
- Deck support posts are either supported in 'U' proprietary brackets (on footing) or supported in a footing. Joists are attached to beams using mini joist hangers.
- Fit timber or composite newel posts after if balustrade is required.

CONSTRUCTION OVER EXISTING PATIO

Ideal only when existing structurally sound concrete slab is present.

- We do not recommend using existing patio slabs as a base as they tend to subside causing problems later. If you do not know what is under the slabs it is best to pull them up and relay.
- Install subframe allowing for 50mm drainage gap all round and drainage gradient of 1:80 (1.25%) as standard.
- Joists are supported off the slabs using strong angle brackets and durable packing pieces.

PRODUCTS REQUIRED TO INSTALL YOUR DECK

After installing your subframe, the Senate items below are crucial to the installation of our safe, long life composite decks. Your order and delivery should include each of the 4 items below. Please contact us asap if you have any queries prior to installation.



Stainless Steel Starter/Finisher Clips



Stainless Steel Locking Clips



Stainless Steel Clip Screws (supplied)



Composite Deck Boards

SPECIFICATION OF TIMBER JOISTS REQUIRED ON ALL DECKS: use class 4 treated timber BSEN 335:1, strength class: C24 or SENATE REINFORCED STEEL COMPOSITE JOISTS

Clear any plants or vegetation, trees and rocks from the area taking care not to disturb any underground cabling or drains. If the area to be decked is currently grass, remove the turf or cover the area with a weed barrier ensuring to bury and tuck the material around the edges.

Once the above has been done, the area **must** be solid prior to installing joists. Standard recommendations such as a concrete base or compacted gravel or hardcore is suitable as it allows for drainage and provides a strong solid structure on which to build the subframe.

JOIST CENTRES

When designing your deck please make note of the joist spacing in your frame.

Composite wood behaves differently to traditional timber, hence for different spacings than you may be used to.

Expansion prediction is crucial when it comes to composite decks.

If you need any advice please let us know prior to commencing the job.

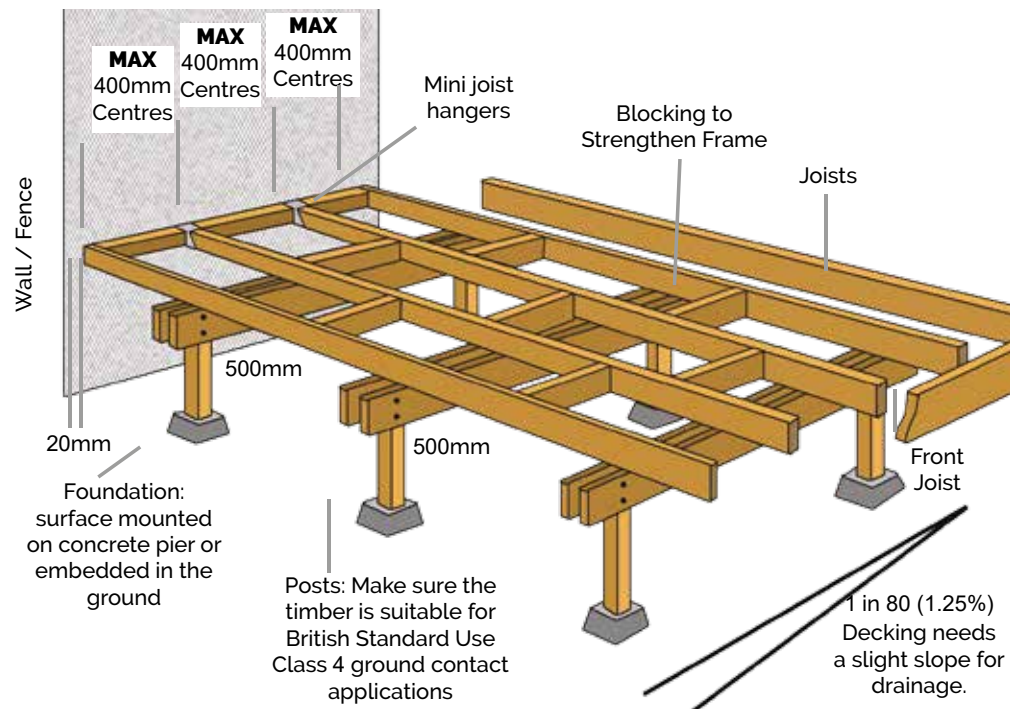

1. Prepare the groundwork prior to commencing the fit. Building regulations and Senate recommend the finished decking surface has a drainage gradient of 1 in 80 (1.25%) to allow for water to "run off" freely.

2. Lay your Joists 400mm centre to centre, running the opposite way to the intended direction of the Deck Boards. Make sure to leave a 20mm gap between any walls / fencing / immovable objects such as fixed planters to allow for expansion.

3. Ensure cross ventilation is allowed around and under the decking.

90° DECK LAYOUT

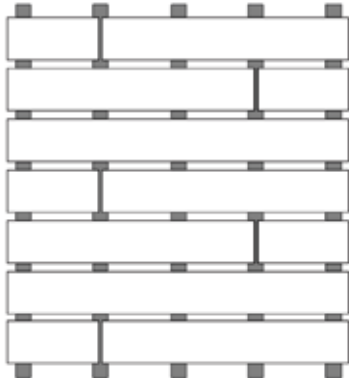

400mm
Centre to Centre

45° DECK LAYOUT

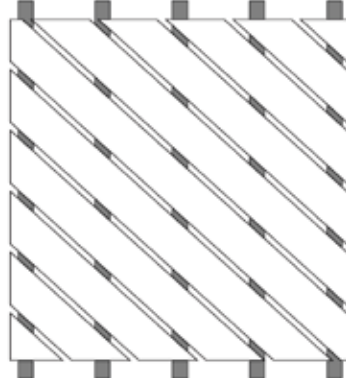

350mm
Centre to Centre

REMEMBER: TO ACHIEVE RAIN WATER "RUN OFF" DECKING SHOULD BE LAID ON A SLIGHT GRADIENT. THE TOTAL LENGTH OF THE DECK SHOULD HAVE A FALL OF AT LEAST 1 IN 80 (1.25%) WITH THE GROOVES IN THE DIRECTION OF THE FALL.

Senate WPC decking boards will expand and contract at a rate of around 0.3% to 0.5% of the boards length. Expansion gaps when boards are to be butted together should be calculated based on this sum, eg. for 2.4m length boards 7mm gap should be left when butting.

To allow for expansion you must allow a 20mm gap when fitting boards short ends on / perpendicular to a solid structure i.e. a wall, stone work, fencing, posts.

For decks with a length over 3.6m, boards should be cut to 1.8m or 2.4m, and 5mm expansion gaps should be left every 1.8m or 2.4m

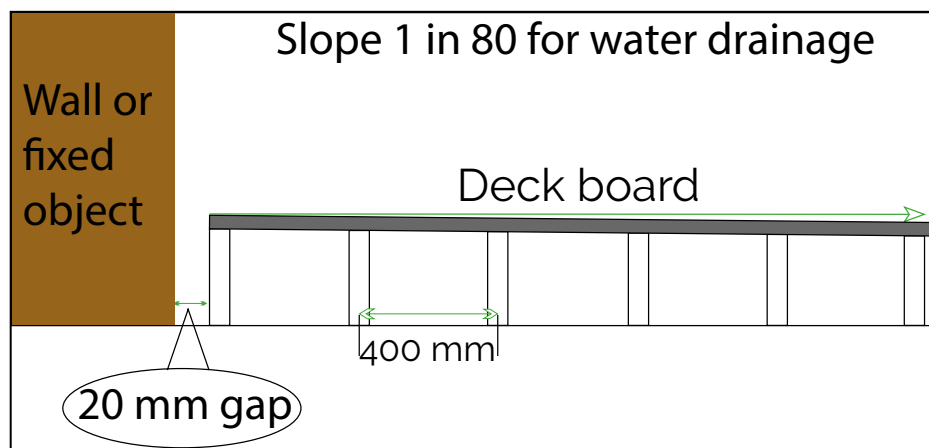

EXAMPLE

For a deck 2m long, if the height of the starting joist (near the wall) is 200mm, the height of the ending joist has to be 175mm.

For every 1000mm length of decking the level needs to fall by 12.5mm to achieve 1:80 run off!

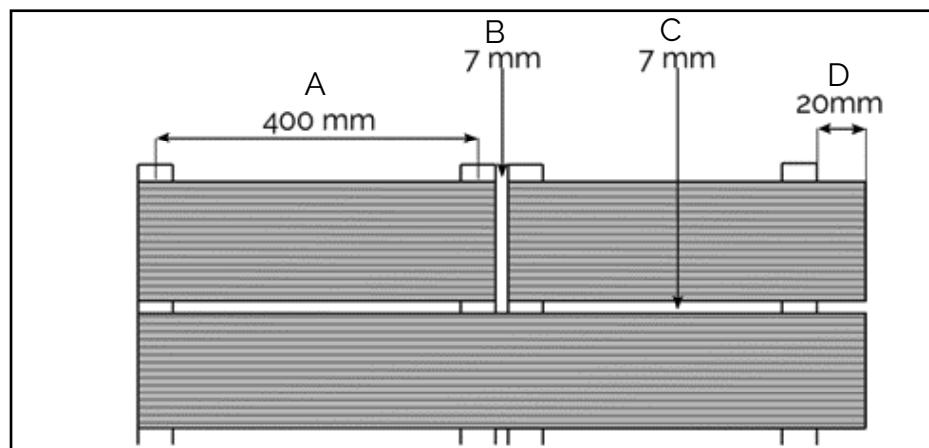

IMPORTANT

- A) Leave 400mm distance from the joists center
- B) 7 mm gap at the putting end of a board and the beginning of a new one
- C) 7 mm between the longside of the boards
- D) Max Overhang is 20mm

HOW TO BUTT BOARDS

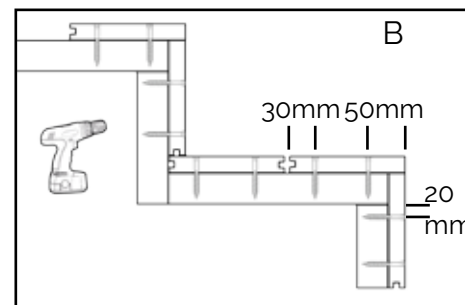
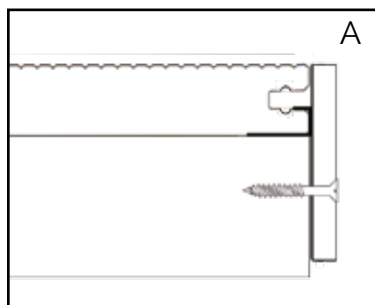
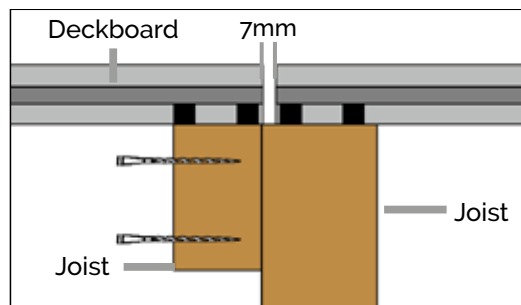

Make sure there is a separate joist under each butted board and clips hold both ends down on both sides.

Edging Trim

Screw the Edging Trim into the joists of the long edge of exposed deck boards. Trim is designed for decorative non walkway edges. (see picture A)

For walkway edges and steps use board configuration. (see picture B)

Coloured coded screws are available on request.

INSTALL YOUR DECKING

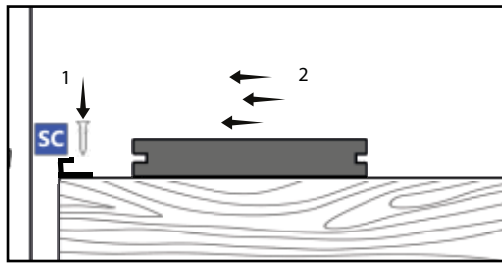

1) Place your **SC** Starter Clips at the start of your decking and fix it with a screw.

1

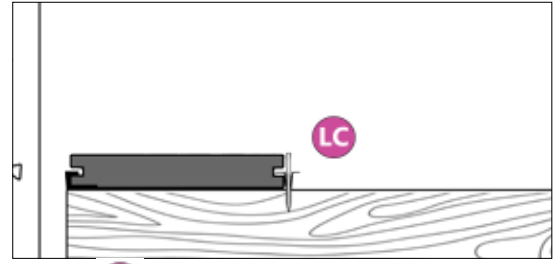

2

3) Clip **LC** Locking Clips into the first board along each of the Joists in the suitable formation. Pre-drill and loosely screw in place about to half the length of the screw.

2) When it's fixed, place your first decking board and lock into the Starter Clip

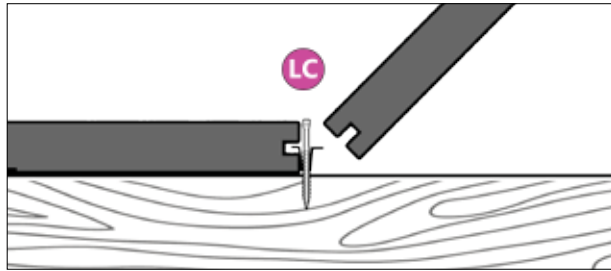

3

Remember to leave a GAP of 7mm between the boards

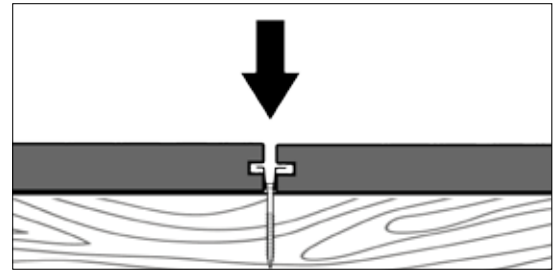

4

5) Fully tighten the screws.

4) Push the next board in into the loosely fitted Locking Clips. Push the board in place

5

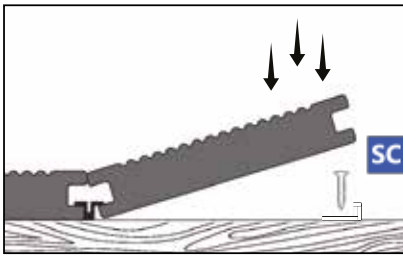

6) Measure out the width of the last board and mark Joists ready for Starter Clips to finish the deck. Pre-drill the holes and screw **SC** Starter Clips in place.

7) Clip your last board into the previous board and push down into place using a rubber mallet if required.

8) Pre-drill and screw any remaining **LC** Locking Clips in place on each joist.

Repeat until your deck is the required dimensions

STEP ONE: LAYING THE JOISTS

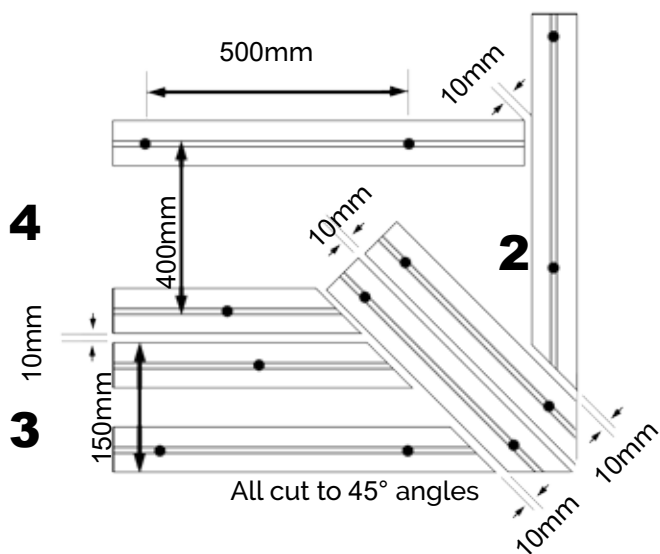

4

3

2

STEP TWO: LAYING THE DECK BOARDS

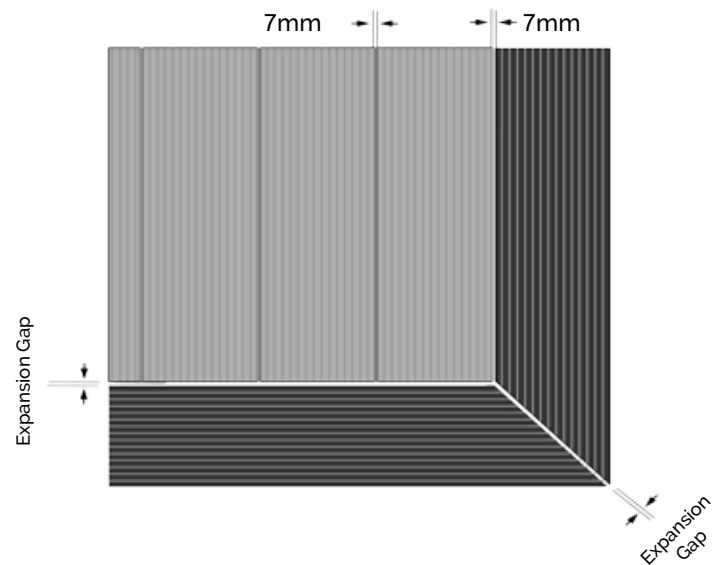

Expansion Gap

Expansion Gap

1. Lay and secure your joists at the suitable centres as per page 4 along the opposite way to the main deck board body.

2. At the corner, lay 2 shortened joists with a 10mm gap cut to a 45° angle. (See 2 on above diagram)

3. Lay another joist 150mm alongside the lower most joist. This will support the framing board. (See 3 on diagram)

4. Lay another joist 10mm away from the last. This will support the edge of the main deck body. (See 4 on diagram)

5. Repeat on the remainder of the corners applicable.

6. Measure out lengths required. Cut your framing boards / Step Boards to 45°.

7. Secure Starter/Finisher Clips at 400mm intervals along the lengths of the outside edge of the subframe.

8. Clip in your cut boards into the Starter Clips to make the frame.

9. Secure Starter/Finisher Clips to the two sides where the main body will have short sides against the frame.

10. Lay the main body of the deck as illustrated above.

MAINTENANCE

Regularly use a brush and hot soapy water to wash Senate WPC. For water stains or any marks caused by birds, berries or leaves, use a soft cleaning detergent to wash off. For harder stains such as marks containing dyes that leave permanent stains, clean the surface using wire wool or sandpaper lightly to carefully remove. If using a power washer to clean your product, keep a distance of at least 30cm from the boards.

Do not use solvent based materials on Senate WPC. Do not stain, oil or paint any Senate WPC without guidance.

MINOR DAMAGE

As with any product that is meant for outdoor use, scratches and acts of nature will inevitably occur.

If this does happen a 200 grit or finer sandpaper can be used to remove the scratch with no detrimental effect to the longevity and performance of the decking.

COLOUR EXPECTANCY

Senate 's composite products will fade due to sun bleaching over time. As our composite wood is a manmade partially recycled product, colour variations and dimension tolerance are to be expected. Our warranty does not cover colour fade, discolouration tolerance or water marks, or stains on our products.

On deliveries colour variations may occur in different batches.

DISCLAIMER

The information given in this publication is based on those guidelines for installation on domestic properties. Commercial decks require more robust design, materials and construction to deal with the loads placed on them and are not covered by the guidance in this brochure.

Senate installation manuals are designed as a general guide. They may not cover every installation scenario envisaged. Since each installation is unique; the installation method used and/or the actual installation and its actual performance are the sole responsibility of the installer.

Senate recommends that all designs be reviewed by a licensed architect or engineer before installation.

Please ensure your plan and/or design meets building regulations and permission before you begin installation.

If you are unsure of the best practices, please use suitably qualified personnel such as GQA accredited to prevent injuries or accidents and get the best performance from Senate products.



Head Office & Warehouse
Unit 4 Senate Place, Whitworth Road
Stevenage, Hertfordshire, SG1 4QS, UK

info@senatecomposites.com | Tel: +44 (0)1438 362547
www.senatecomposites.com